LMD9014

USER MANUAL

osee

PRODUCT INFORMATION

MODEL: LMD9014 LCD MONITOR
Version: V020000
Release Date: 2010-4-23

COMPANY NAME

Beijing Osee Digital Technology Ltd.

CONTACT INFORMATION

Address: Room 702, Tower D, Jinyujiahua Building, No.9, 3rd Shangdi Street, Haidian District, Beijing, China
Post code: 100085
Tel: 8610-62968823
Fax: 8610-62977165
[Http://www.osee-dig.com](http://www.osee-dig.com)
E-mail: sales@osee-dig.com

About The USER MANUAL

The user manual applies to the following device types:

- LMD9014-HSC
- LMD9014-SC
- LMD9014-V

The images of LMD9014-HSC are adopted in the following descriptions. Any of the different specifications between the device types are elaborated. Before reading the manual, please confirm the device type.

Contents

Chapter 1	Product Overview	1
Chapter 2	Safety Precaution for Use	2
Chapter 3	Unpacking and Installation	3
Chapter 4	Using the LMD9014	4
4.1	Status Display of the Screen	4
4.2	Front Panel Controls	5
4.3	Quick Button Descriptions	7
4.3.1	ENTER BUTTON	7
4.3.2	USER1~ USER3 BUTTON	7
4.3.3	MENU BUTTON	9
4.4	Rear Panel	9
Chapter 5	Main Menu Structure	11
5.1	STATUS Sub-menu	11
5.2	VIDEO Sub-menu	11
5.3	AUDIO Sub-menu	12
5.4	MARKER Sub-menu	14
5.5	OSD Sub-menu	15
5.6	USER CONTROL Sub-menu	18
5.7	USER CONFIG Sub-menu	19
Chapter 6	Technical Specifications	20
Chapter 7	Supplying the power	23
Chapter 8	Warranty for LCD Monitor	24

Chapter 1 Product Overview

The LMD9014 is a 4U Standalone LCD monitor that offers video and audio monitoring with high resolution of 800x480. The unit is equipped with full digital processing technology, and its screen features anti-glare. The model accepts HD-SDI, SD-SDI and analog composite signal. A high display quality of all video signals can be ensured by full digital processing. The precise scaling chip as well as Gamma correction is a guarantee for high quality display image.

The monitor comes with many in monitor display features including WFM, Vectorscope as well as RS485.

Features:

- ★ Auto- Sensing for HD/SD-SDI, Composite signal
- ★ Embedded Audio Support, 4 or 8 Channels Audio Meter (VU & PPM)
- ★ H/V Delay, Under Scan, Safe&Area Marker, Aspect Ratio, Blue Only, Tally
- ★ 1 Pair Audio Monitoring via Headphone Jack. Built-in speaker.
- ★ Support COLOR temperature correction.
- ★ Support Dynamic UMD, and TSL and IMAGE VIDEO protocols.
- ★ Waveform and Vectorscope display for SDI signal
- ★ Support OSD TALLY (SPLIT TALLY); Support LED TALLY.
- ★ Support SD ASPECT. When the input is CVBS or SD-SDI, it supports 16:9 and 4:3 display.
- ★ An interface is displayed when USER menu is under operation.

Product Number	Description
LMD9014-HSC	The monitor includes two video inputs (support HD-SDI / SD-SDI / CVBS), four external audio input connectors.
LMD9014-SC	The monitor includes two video inputs (support SD-SDI / CVBS) , four external audio input connectors.
LMD9014-V	The monitor includes two video inputs (support CVBS), four external audio input connectors.

Chapter 2 Safety Precaution for Use

Read and keep these instructions. Heed all warnings. Follow all instructions.

About the Position

1. Do not block any ventilation openings.
2. Do not use this unit near water.
3. Do not expose the unit to rain or moisture.
4. Do not install near any heat sources such as radiators, heat registers, stoves, or other apparatus (including amplifiers) that product heat.
5. A nameplate indicating operating voltage, etc., is located on the rear panel. Install only in accordance with the instructions in the section entitled, “Unpacking and Installation” on page 3.
6. The socket-outlet shall be installed near the equipment and shall be easily accessible.

About the Power-supply Cord

7. Do not defeat the safety purpose of the polarized or grounding-type plug.
8. Do not damage the power cord, place the heavy objects on the power cord, stretch the power cord, or bend the power cord.
9. Protect the power cord from being walked on or pinched, particularly at plugs, convenience receptacles, and the point where they exit from the unit.
10. If the power cord is damaged, turn off the power immediately. It is dangerous to use the unit with a damaged power cord. It may cause fire or electric shock.
11. Unplug this apparatus during lightning storms or when unused for long periods of time.
12. Disconnect the power cord from the AC outlet by grasping the plug, not by pulling the cord.
13. Should any solid object or liquid fall into the cabinet, unplug the unit and have it checked by qualified personnel before operating it any further.

Monitor

14. Do not beat with a hard object or scratch the LCD display.
15. Do not make the freeze picture displaying on the screen time too long, otherwise, it will leave the afterimage on the screen.
16. Install in accordance with the manufacturer’s instructions
17. If the brightness is adjusted to the minimum, then it might be hard to see the display screen.
18. Refer all servicing to qualified service personnel. Servicing will be required under all of the following conditions:
 - The unit has been exposed to rain or moisture.
 - Liquid had been spilled or objects have fallen onto the unit.
 - The unit has been damaged in any way, such as when the power-supply cord or plug is damaged.
 - The unit does not operate normally.
19. Clean only with dry cloth.
20. Specifications are subject to change without notice.

Chapter 3 Unpacking and Installation

1. Unpack the LMD9014 Monitor and inspect for any apparent physical damage that may have occurred in transit. We recommend you retain the shipping carton for future use. If there be any damage, immediately contact OSEE DIGITAL TECHNOLOGY LTD at +86-010-62968823.
2. After inspection, install in your desired location of a standard EIA 19-inch equipment rack. Adequate ventilation is required when installed to prevent possible damage to the LMD9014 internal components.
3. Connect required cables for signal input and output. Please note that power must be applied to the LMD9014 for all outputs to be activated. For BNC connections use 75 Ω rated connectors.
4. Connect A.C. Mains power using the included power cord. Please ensure an Earth ground present to ensure proper operation of the unit. Fasten the power protect accessory.
5. As a final step turn on each screen of the LMD9014 by depressing the power switch located on the front of the unit.

Supplied Accessories:

- | | |
|-------------------------|---|
| 1. Monitor | 1 |
| 2. 12 V DC power supply | 1 |
| 3. User Manual | 1 |
| 4. Warranty Card | 1 |

Optional unit:

5. BH-AB : Anton /Bauser battery holder
6. BH-VM : V-mount battery holder

Chapter 4 Using the LMD9014

4.1 Status Display of the Screen

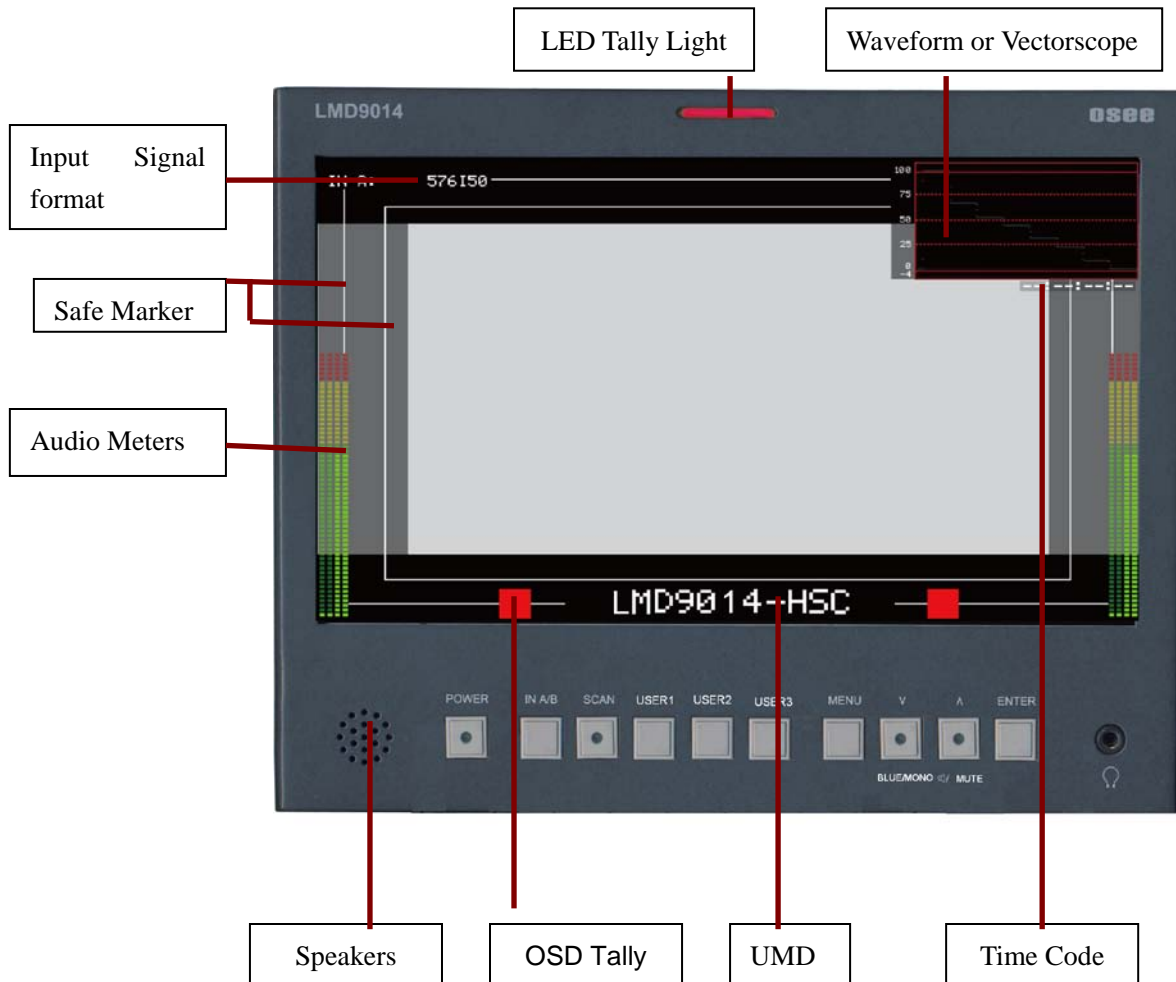

1. **LED Tally Light:** This tri-color (red/green/amber) light is controlled through a DB9 connector on the rear panel. For more information about the DB9 connector, refer to “Rear Panel” on Chapter 4.4.
2. **Input Signal Format:** It displays the input signal format and can be set in the MAIN Menu.
3. **Safe Areas:** Multiple safe areas are configurable in the MAIN Menu.
4. **Audio Meters:** Levels for the audio. For LMD9014-SC and LMD9014-V, only two meters on the left side.
5. **UMD:** The MAIN Menu provides settings to customize the UMD (In-Monitor Display) text area to show a line of characters, numbers, and/or some symbols.
6. **Speakers:** Audio may be selected for monitoring through the left and right speakers.
7. **Time Code:** The de-embedded time code from the HD/SD-SDI source displays in the top right corner.
8. **Waveform and Vectorscope:** The signal waveform and vectorscope are configurable in the MAIN Menu.

- Referring to the circumstance of no sync (power on):
 1. Will indicate on the top left hand of screen: IN A: NO SYNC
 2. On the bottom of screen will UMD and METER be shown, but the display of UMD and METER is subject to the current main menu setting. When in the main menu UMD DISP is set to ON and, no video input, UMD will display; when it is set OFF, UMD won't be displayed. The same applies to the display of METER.
 3. The main menu can still be displayed, but the value of parameter relating to image is not adjustable; and the value of parameter relating to the display effect can be adjustable.

4.2 Front Panel Controls

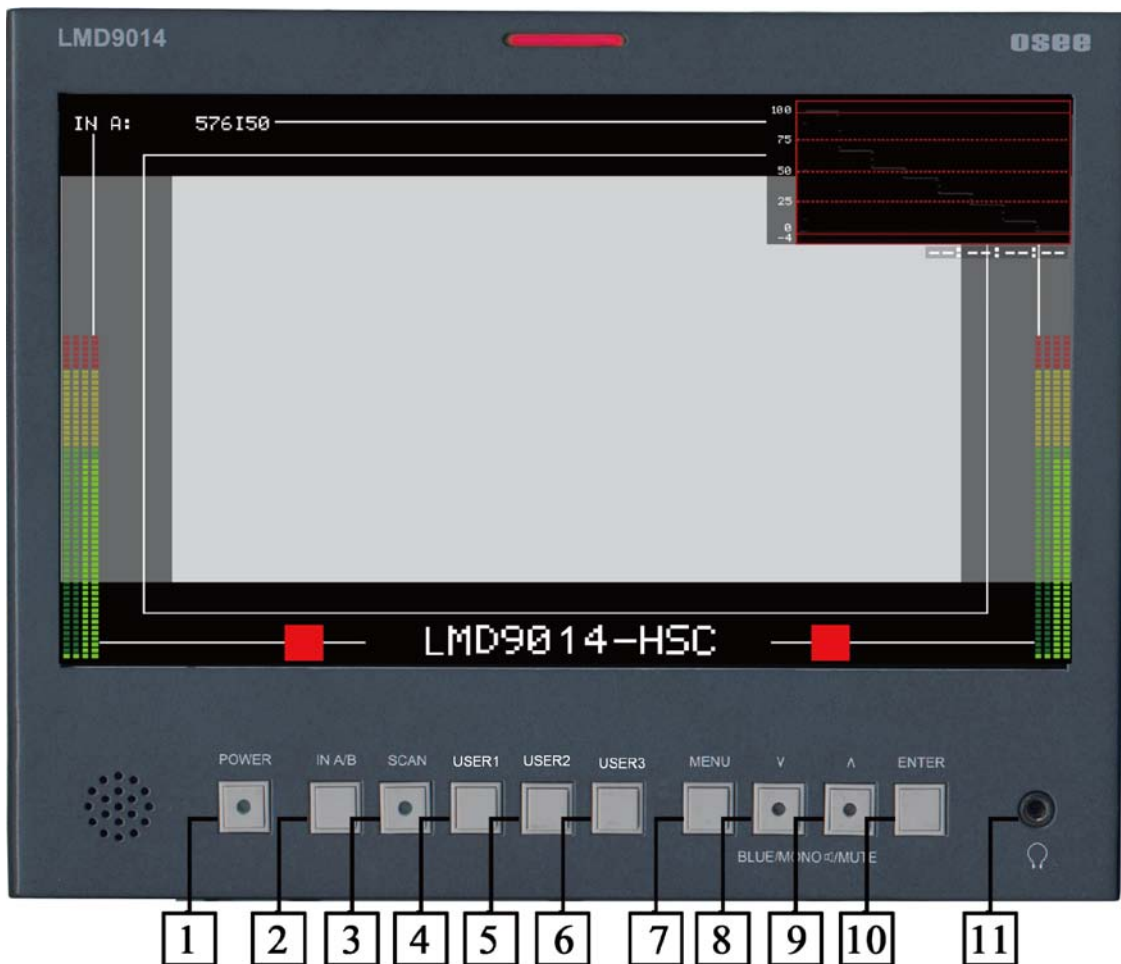

1: Power On/Off Switch

When the indicator in the power switch is in green, it indicates that power is on.

When the indicator is flashing, it indicates standby.

2: IN A/B

Press to select one input signal from two input channels.

3: SCAN

Press to display the 100% image (UNDER SCAN) and 95% (NORMAL) image.

4/5/6: USER1~ USER3

“USER1~ USER3” serve as the quick-button; its function can be assigned in the main MENU.

(For more information, please refer to “Chapter 4.3.2”)

7: MENU

Press to display the main menu. (For more information, please refer to “Chapter 4.3.3” and Chapter5)

8/9: Two functions

- Press “MENU” button to choose the function you need.
- When the “MENU” is not in use, the button of 8/9 can achieve the following functions:

8. Blue only and mono button:

➤ **Blue only:** press to eliminate the red and green signals. Only blue signal is displayed as an apparent monochrome picture on the screen.

➤ **Mono:** press to display a monochrome picture.

➤ Press the button repeatedly, the button function will circle as follows:

Blue only → mono → color mode



9. Audio Selection and MUTE button

➤ **Audio Selection:** press to select the monitoring audio of the corresponding monitor.

➤ **Mute:** press to mute the sound. “MUTE” will show a continuous flickering lasting for 10S.

To cancel the mute function, press the button again.

➤ Press the button repeatedly, the button function will circle as follows:

Audio Selection → Mute

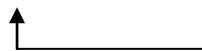

Note: The indicator in lighting shows its audio is being monitored; in flickering shows its audio is being muted of corresponding monitor.

10: Enter

- Enter the menu items when menu is displayed;
- Enter instant parameters adjustment when menu isn’t displayed. The following parameters can be regulated: VOLUME, BRIGHTNESS, CONTRAST, SATURATION, SHARPNESS, HUE.
(For more information, please refer to “Chapter 4.3.1”)

11: HEADPHONE Jack: 3.5mm Stereo HEADPHONE Jack

4.3 Quick Button Descriptions

4.3.1 ENTER BUTTON

When MENU is not used, you can press ENTER to regulate the following parameters: VOLUME, BRIGHTNESS, CONTRAST, SATURATION, SHARPNESS, and HUE.

Press ENTER six times, parameters will cycle. You can get the exact value combined with buttons of \wedge (up) or \vee (down).

- **VOLUME:** Used to regulate the volume. Range: -30~0dB, the maximum: 0dB.
- **BRIGHTNESS:** Used to regulate the brightness, range: -116~139, the typical: 0.
- **CONTRAST:** Used to regulate the contrast of image, range: -128~127, the typical: 0.
- **SATURATION:** Used to regulate the saturation of image, range: -128~127, the typical: 0.
- **SHARPNESS:** Used to regulate the sharpness of image, range: 0~15, the typical: 0.
- **HUE:** Used to regulate the hue of image, range: -32~31, the typical: 0.

Note: To regulate the option DEFAULT, use the reset item in video 1/2 of the main MENU. You can reset the following parameters of BRIGHTNESS, CONTRAST, SATURATION, SHARPNESS, and HUE.

4.3.2 USER1~ USER3 BUTTON

Press the USER1~ USER3 buttons on the front panel; it will display the following table. The table will disappear after 3 seconds without operation.

USER	FUNCTION
USER 1	H/V DELAY OFF
USER 2	SD ASPECT 16:9
USER 3	WFM DISP WFM

USER1~ USER3 can be used as quick-button, and include many options. When you choose one option, for example, if you have already set USER1 at H/V DELAY, you can press “USER1” directly to realize each function of H/V DELAY, and need not set in the main MENU. Of course you can set “USER1” at other option accordingly.

The function of USER1~ USER3 can be set in the main MENU. Set steps: press MENU, combined with buttons of \wedge (up) or \vee (down), you can find “USER CONFIG” in the sub-MENU, also combined with buttons of \wedge (up) or \vee (down), and you will find USER1~ USER3.

The different apparatus model includes different user menu items.

The options are as follows. (The underlined value means the DEFAULT value.)

		User Menu Items		
MODEL		LMD9014-V	LMD9014-SC	LMD9014-HSC
BUTTON	ITEM			
USER 1		<ul style="list-style-type: none"> ● <u>SD ASPECT*</u> ● SAFE MARKER ● AREA MARKER ● OSD CONTROL ● MON SOURCE 	<ul style="list-style-type: none"> ● <u>H/V DELAY</u> ● SD ASPECT* ● WFM DISP ● SAFE MARKER ● AREA MARKER ● OSD CONTROL ● MON SOURCE 	<ul style="list-style-type: none"> ● <u>H/V DELAY</u> ● SD ASPECT* ● WFM DISP ● SAFE MARKER ● AREA MARKER ● OSD CONTROL ● MON SOURCE
USER 2		<ul style="list-style-type: none"> ● SD ASPECT* ● <u>SAFE MARKER</u> ● AREA MARKER ● OSD CONTROL ● MON SOURCE 	<ul style="list-style-type: none"> ● H/V DELAY ● <u>SD ASPECT*</u> ● WFM DISP ● SAFE MARKER ● AREA MARKER ● OSD CONTROL ● MON SOURCE 	<ul style="list-style-type: none"> ● H/V DELAY ● <u>SD ASPECT*</u> ● WFM DISP ● SAFE MARKER ● AREA MARKER ● OSD CONTROL ● MON SOURCE
USER 3		<ul style="list-style-type: none"> ● SD ASPECT* ● SAFE MARKER ● AREA MARKER ● OSD CONTROL ● <u>MON SOURCE</u> 	<ul style="list-style-type: none"> ● H/V DELAY ● SD ASPECT* ● <u>WFM DISP</u> ● SAFE MARKER ● AREA MARKER ● OSD CONTROL ● MON SOURCE 	<ul style="list-style-type: none"> ● H/V DELAY ● SD ASPECT* ● <u>WFM DISP</u> ● SAFE MARKER ● AREA MARKER ● OSD CONTROL ● MON SOURCE

And each option will be specified as follows.

- ◆ **H/V DELAY:** H/V, V, H, OFF. Function: horizontal/vertical blank, vertical blank, horizontal blank, or no blank.
- ◆ **SD ASPECT:** Change the aspect ratio of the picture between 4:3 and 16:9. Only used for CVBS and SD-SDI input signal. (For more information, please refer to Chapter 5.6)
- ◆ **WFM DISP:** It is used to check the waveform / VECTOR of the current signal picture, showing on the top-right of the screen. Include three options of WFM, VECTOR, OFF.
- ◆ **SAFE MARKER:** Display CENTER mark, 90% mark and 80% mark or not.
- ◆ **AREA MARKER:** Images show with one scale of 2.35:1, 1.85:1, 15:9, 14:9, 13:9, 4:3 or OFF. Only when ASPECT is at 16:9, the setting is available.
- ◆ **OSD CONTROL:** Display waveform / VECTOR / TC code, UMD code and audio meter or not.
- ◆ **MON SOURCE:** Monitor one audio source of four audio sources. Include four options of MET1, MET2, MET3 and MET4. When MET1 is selected, the first audio source will be monitored. Likewise, if you select other MET, the corresponding audio source will be monitored.

Note: Please set “USER1~ USER3” to meet your actual requirement. For example, if you often use H/V DELAY, you’d better set “USER1” at H/V DELAY.

4.3.3 MENU BUTTON

When you want to change the value of a parameter, you may use MENU, and you can follow four steps.

➤ Step 1:

Press MENU, and you can enter the main MENU.

➤ Step 2:

Press buttons of \wedge (up) or \vee (down) to choose an option, and the selected sub-MENU icon will display in yellow. When you get one and press ENTER, and you can enter the sub-MENU.

➤ Step 3:

Press buttons of \wedge (up) or \vee (down) to choose a parameter, and the selected parameter will display in yellow. Press ENTER, and press \wedge or \vee to acquire the exact value. Press ENTER to set some value.

➤ Step 4:

Press MENU to return. You can follow the same step to set other parameters.

In a word, when you set a parameter, the buttons of ENTER, MENU, \wedge and \vee will be used frequently. The function of each button is listed below.

 **ENTER:** Enter the sub-menu and set the value of a parameter.

 **MENU:** Return to the super-menu with no saving.

 **\wedge (up) or \vee (down):** Switch the options in the same menu.

Note: in all sub-menu of main menu, pressing “Menu” is to cancel the current set value and return back to the menu of top level. If setting a value of some parameter, it’s required to press “Enter” to save current set value.

4.4 Rear Panel

Connectors

HD-SDI/SD-SDI inputs comply with SMPTE259M, SMPTE292M / ITU-R BT601.

Composite Video inputs comply with SMPTE-170M.

Tally lamps are active, when connected to ground.

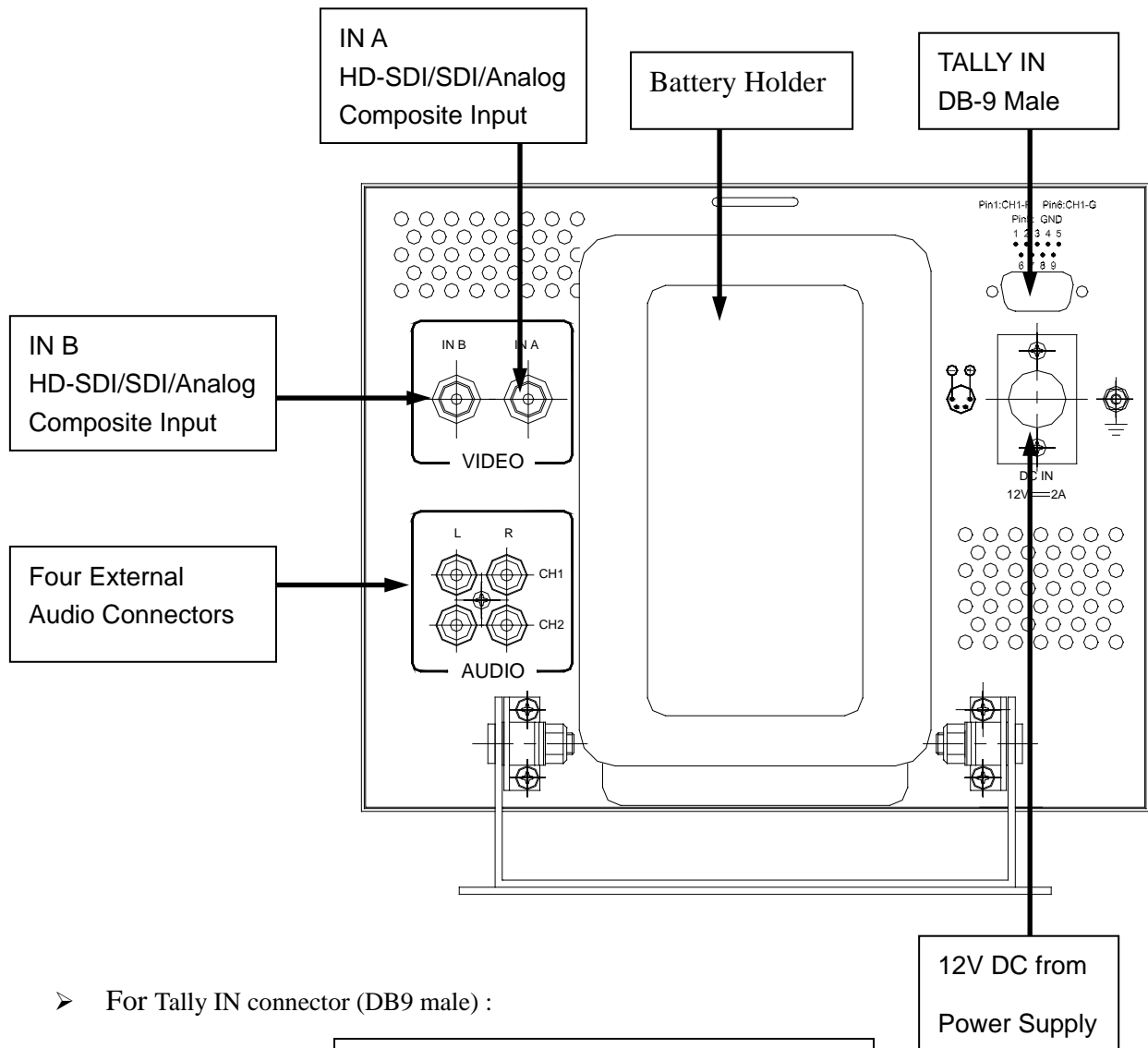

➤ For Tally IN connector (DB9 male) :

Tally IN (DB-9 Male)			
Pin 1	CH1-R	Pin 6	CH1-G
Pin 2	/	Pin 7	/
Pin 3	/	Pin 8	/
Pin 4	/	Pin 9	/
Pin 5	GND		

Tally Light Color	Screen 1	
	PIN1	PIN6
Red	GND	Open
Green	Open	GND
Amber	GND	GND

➤ **Note:** For more information of Power Supply and Battery Holder, please refer to chapter 7.

Chapter 5 Main Menu Structure

The descriptions of main menu structure are as follows:

(The operation of main menu refers to Chapter 4.3.3)

The main menu includes seven sub-menu icons. The sub-menus are:

- A. STATUS
- B. VIDEO
- C. AUDIO
- D. MARKER
- E. OSD
- F. USER CONTROL
- G. USER CONFIG

Note: For the following menu description, “O” stands for the unit including this function; whereas “X” indicates the unit includes no such function. The underlined values are factory preset setting values. (The presets are values adjusted before shipment from factories.) The available parameters and values show in white; the unavailable parameters and values show in blue.

5.1 STATUS Sub-menu

The STATUS Sub-menu is used to display the current status of the unit. The following items are displayed:

Parameters	Input Signal			Display Value
	CVBS	SD-SDI	HD-SDI	
FORMAT	O	O	O	IN A 1080I60
COLOR TEMP	O	O	O	D65
MON SOURCE	O	O	O	MET 1
SCAN	O	O	O	NORMAL
SD ASPECT	O	O	O	16: 9
MODEL	O	O	O	LMD9014-HSC

This Sub-menu can't be entered, only displays information. The model will display corresponding unit type depending on the actual unit.

5.2 VIDEO Sub-menu

Parameters	Input Signal			Domain Range	NOTE
	CVBS	SD-SDI	HD-SDI		
VIDEO (1/2)					
BRIGHTNESS	O	O	O	-116... <u>000</u> ...139	Adjust the picture brightness
CONTRAST	O	O	O	-128... <u>000</u> ...127	Adjust the picture contrast
SATURATION	O	O	O	-128... <u>000</u> ...127	Adjust the picture saturation
SHARPNESS	O	O	O	<u>000</u> ...15	Adjust the picture sharpness
HUE	O	O	O	-32... <u>000</u> ...31	Adjust the picture hue
RESET	O	O	O		Reset BRIGHTNESS, CONTRAST, SATURATION, SHARPNESS, and HUE to default value. Once “Reset” is set, all parameters above will respond to change.

COLOR TEMP	<input type="radio"/>	<input type="radio"/>	<input type="radio"/>	USR...D56... <u>D65</u> ...D93	Used to select the color temperature that will become the basis for adjustments. <ul style="list-style-type: none"> • <USR> Color temperature of user set. • <D56> Color temperature around 5600K • <D65> Color temperature around 6500K • <D93>Color temperature around 9300K
VIDEO (2/2)					
R GAIN	<input type="radio"/>	<input type="radio"/>	<input type="radio"/>	0... <u>128</u> ...255	Gain elements for RED are adjusted.
G GAIN	<input type="radio"/>	<input type="radio"/>	<input type="radio"/>	0... <u>128</u> ...255	Gain elements for GREEN are adjusted.
B GAIN	<input type="radio"/>	<input type="radio"/>	<input type="radio"/>	0... <u>128</u> ...255	Gain elements for BLUE are adjusted.
R OFFSET	<input type="radio"/>	<input type="radio"/>	<input type="radio"/>	0... <u>128</u> ...255	Offset elements for RED are adjusted.
G OFFSET	<input type="radio"/>	<input type="radio"/>	<input type="radio"/>	0... <u>128</u> ...255	Offset elements for GREEN are adjusted.
B OFFSET	<input type="radio"/>	<input type="radio"/>	<input type="radio"/>	0... <u>128</u> ...255	Offset elements for BLUE are adjusted.
RESET	<input type="radio"/>	<input type="radio"/>	<input type="radio"/>		“R GAIN”- “B OFFSET” values are reset to color temperatures values selected in “COLOR TEMP”.

NOTE:

When adjusting, the item displays of “BRIGHTNESS”-“HUE” and “R GAIN”-“B OFFSET” move to the lower part of the screen.

5.3 AUDIO Sub-menu

PARAMETERS	Input Signal			Domain Range	NOTE
	CVBS	SD-SDI	HD-SDI		
AUDIO (1/5)					
AUDIO MON	<input type="radio"/>	<input type="radio"/>	<input type="radio"/>	<u>ON</u> ...OFF	Used for headphone. The default of left panel is set to ON, others is set to OFF. “AUDIO MON” can be only set from “OFF” to “ON”, a reverse cannot be allowed.
MON SOURCE	<input type="radio"/>	<input type="radio"/>	<input type="radio"/>	<u>MET 1</u> ...MET 4	Used to set the monitoring audio source from among audio meters. Note: For LMD9014-HSC, there are four audio meters (MET1~MET4). For LMD9014-SC/ LMD9014-V, there are only two audio meters (MET1~MET2).
VOLUME	<input type="radio"/>	<input type="radio"/>	<input type="radio"/>	<u>00dB</u> ...-30dB...MUTE	Used to adjust the volume value. “MUTE” changes to a continuous flickering lasting for 10S.
METER SIZE	<input type="radio"/>	<input type="radio"/>	<input type="radio"/>	<u>SMALL</u> ...LARGE	Used to set the size of the audio meter display.
METER H POS L	<input type="radio"/>	<input type="radio"/>	<input type="radio"/>	<u>000</u> ...255	Used to set the horizontal position of left audio meter.
METER H POS R	<input type="radio"/>	<input type="radio"/>	<input type="radio"/>	<u>000</u> ...255	Used to set the horizontal position of right audio meter. Only used for LMD9014-HSC.
TEST LEV	<input type="radio"/>	<input type="radio"/>	<input type="radio"/>	-18dB... <u>20dB</u>	Used to set the test level of audio meter.

AUDIO (2/5)					
IN A: MET 1	O	O	O	NONE...VU ...PK... <u>VU+PK</u>	Used to set the audio meter types with the input signal from INA connector.
IN A: MET 2	O	O	O	NONE...VU ...PK... <u>VU+PK</u>	Note: For LMD9014-HSC, there are four audio meters (MET1~MET4).
IN A: MET 3	O	O	O	NONE...VU ...PK... <u>VU+PK</u>	For LMD9014-SC/LMD9014-V, there are only two audio meters (MET1~MET2).
IN A: MET 4	O	O	O	NONE...VU ...PK... <u>VU+PK</u>	
IN A: MET 1-L	O	O	O	<u>EBD1</u>	For the input signal from INA connector, it is used to assign the audio channel for left audio meter 1 display from among “EBD1...EBD16” and “EXT1L...EXT2R”. ✚ For LMD9014-V, only four options: “EXT1L...EXT2R”
IN A: MET 1-R	O	O	O	<u>EBD2</u>	For the input signal from INA connector, it is used to assign the audio channel for right audio meter 1 display from among “EBD1...EBD16” and “EXT1L...EXT2R”. ✚ For LMD9014-V, only four options: “EXT1L...EXT2R”
IN A: MET 2-L	O	O	O	<u>EBD3</u>	The similar as INA meter 1.
AUDIO (3/5)					
IN A: MET 2-R	O	O	O	<u>EBD4</u>	The similar as INA meter 1.
IN A: MET 3-L	O	O	O	<u>EBD5</u>	The similar as INA meter 1. Only used for LMD9014-HSC.
IN A: MET 3-R	O	O	O	<u>EBD6</u>	The similar as INA meter 1. Only used for LMD9014-HSC.
IN A: MET 4-L	O	O	O	<u>EBD7</u>	The similar as INA meter 1. Only used for LMD9014-HSC.
IN A: MET 4-R	O	O	O	<u>EBD8</u>	The similar as INA meter 1. Only used for LMD9014-HSC.
IN B: MET 1	O	O	O	NONE...VU ...PK... <u>VU+PK</u>	For the input signal from INB connector, it is used to set the audio meter types with the input signal from INB connector.
IN B: MET 2	O	O	O	NONE...VU ...PK... <u>VU+PK</u>	Note:
AUDIO (4/5)					For LMD9014-HSC, there are four audio meters (MET1~MET4).
IN B: MET 3	O	O	O	NONE...VU ...PK... <u>VU+PK</u>	For LMD9014-SC/ LMD9014-V, there are only two audio meters (MET1~MET2).
IN B: MET 4	O	O	O	NONE...VU ...PK... <u>VU+PK</u>	

IN B: MET 1-L	O	O	O	<u>EBD1</u>	For the input signal from INB connector, it is used to assign the audio channel for left audio meter 1 display from among “EBD1...EBD16” and “EXT1L...EXT2R”. ➤ For LMD9014-V, only four options: “EXT1L...EXT2R”
IN B: MET 1-R	O	O	O	<u>EBD2</u>	For the input signal from INB connector, it is used to assign the audio channel for right audio meter 1 display from among “EBD1...EBD16” and “EXT1L...EXT2R”. ➤ For LMD9014-V, only four options: “EXT1L...EXT2R”
IN B: MET 2-L	O	O	O	<u>EBD3</u>	The similar as INB meter 1.
IN B: MET 2-R	O	O	O	<u>EBD4</u>	The similar as INB meter 1.
IN B: MET 3-L	O	O	O	<u>EBD5</u>	The similar as INB meter 1. Only used for LMD9014-HSC.
AUDIO (5/5)					
IN B: MET 3-R	O	O	O	<u>EBD6</u>	The similar as INB meter 1. Only used for LMD9014-HSC.
IN B: MET 4-L	O	O	O	<u>EBD7</u>	The similar as INB meter 1. Only used for LMD9014-HSC.
IN B: MET 4-R	O	O	O	<u>EBD8</u>	The similar as INB meter 1. Only used for LMD9014-HSC.

5.4 MARKER Sub-menu

PARAMETERS	Input Signal			Domain Range	NOTE
	CVBS	SD-SDI	HD-SDI		
SAFE MARKER ¹	O	O	O	<u>ON</u> ...OFF	Select ON to enable the safe area mark of the picture display and OFF not to display.
CENTER	O	O	O	ON... <u>OFF</u>	Select ON to display the center mark of the picture and OFF not to display. No function in h/v delay mode
90%	O	O	O	ON... <u>OFF</u>	Select ON to enable the 90% safe area size of the image display and OFF not to display. No function in h/v delay mode
80%	O	O	O	ON... <u>OFF</u>	Select ON to enable the 80% safe area size of the image display and OFF not to display. No function in h/v delay mode
AREA MARKER ²	X	O	O	<u>OFF</u> ...2.35:1 ...1.85:1...15:9 ...14:9...13:9 ...4:3	Used to set type of the area marker. No function in h/v delay mode and in 4:3 aspect ratio for SD SDI input.

Note: 1. SAFE MARKER

- When SAFE MARKER is set to ON, the value of “CENTER”, “90%”, “80%” changes between ON, OFF. Each function is available.
 - When SAFE MARKER is set to OFF, the functions of “CENTER”, “90%”, “80%” are not available.
2. Refer to the “AREA MARKER” parameter:
- Only when the image displaying in 16: 9 format, this function is available.

5.5 OSD Sub-menu

PARAMETERS	Input Signal			Domain Range	NOTE
	CVBS	SD-SDI	HD-SDI		
OSD (1/3)					
STD DISP	O	O	O	ON... <u>AUTO OFF</u> ...OFF	Displays the input signal format on the top left of the screen. <ul style="list-style-type: none"> • ON = Always displayed • AUTO OFF= Displayed for about 10 seconds after change • OFF = Hidden
WFM/VT DISP	X	O	O	VECTOR...WFM... <u>OFF</u>	<ul style="list-style-type: none"> •VECTOR: Displays vectorscope. •WFM: Displays waveform • OFF: not to display
TC DISP	X	O	O	ON... <u>OFF</u>	<ul style="list-style-type: none"> • ON: Displays the time code • OFF: not to display
UMD DISP	O	O	O	<u>ON</u> ...OFF	<ul style="list-style-type: none"> • ON: Displays UMD • OFF: not to display
OSD TLY DISP * ¹	O	O	O	<u>ON</u> ...OFF	
OSD TLY MODE * ¹	O	O	O	<u>RGY</u> ...GR...GR	
LED TLY DISP * ²	O	O	O	<u>ON</u> ...OFF	
OSD (2/3)					
UMD FIXED SETUP * ³	O	O	O	@ABCDEFGHIJKLMNO	16 CHARS
COLOR * ⁴	O	O	O	RED...GREEN ...YELLOW... <u>WHITE</u>	
ALIGN * ⁵	O	O	O	LEFT... <u>CENTER</u> ... RIGHT	
UMD PROTOCOL * ⁶	O	O	O	<u>LOCAL</u> ...TSL V3.1 ...TSL V4.0...IMAGE VIDEO	
UMD ID * ⁷	O	O	O	0...255	The device can be set independently through the downloading software and with the set value, convenient for remote control
OSD (3/3)					
UMD NAME(S/N) * ⁸	O	O	O	S00000	16 Characters totally. UMD NAME is in compliance with IMAGE VIDEO Protocol

UMD TLY MODE *9	O	O	O	T1...T2... <u>T1T2</u> ...T2T1 ...T1-...T2-...T1T2- ...T2T1-...	UMD TLY MODE is in compliance with IMAGE VIDEO Protocol
UMD BAUD RATE *10	O	O	O	2400...4800...9600... 19200...38400...57600... <u>115200</u>	
TLY SOURCE *11	O	O	O	<u>STANDARD</u> ...IMAGE VIDEO HW...IMAGE VIDEO 422... STANDARD+IV422... TSL	

NOTES:
***1. OSD TLY DISP, OSD TLY MODE**

Use these settings to choose how tally is displayed on the screen. The available OSD Tally options depend on the Tally Source. **OSD TLY DISP** can be set to **Off**, **ON**; **OSD TLY MODE** can be set to **RGY**, **RG**, or **GR**:

When the Tally Source is set to STANDARD or STANDARD+IV422, OSD TLY MODE is available.

When the Tally Source is set to IMAGE VIDEO 422, TSL and IMAGE VIDEO HW, OSD TLY MODE is unavailable.

- Off: On-screen tally is disabled.
- ON: On-screen tally is enabled.
- RGY: Red, yellow, or green tally signals are indicated at both the bottom left and bottom right corners of the screen near UMD.
- RG: Red tally is shown at the bottom left of the screen and green is shown at the bottom right.
- GR: Green tally is shown at the bottom left of the screen and red is shown at the bottom right.

***2. LED TLY DISP**

Use this setting to enable or disable the LED Tally. When it is set to ON, the yellow, red and green LED above each display will respond to tally commands, according to the Tally Source setting.

***3. UMD FIXED SETUP**

Use this setting to display static UMD text on the screen. This setting is used to enter UMD text locally, when a serial protocol is not used for remote control. The UMD will be overridden by serial protocol commands.

Press ENTER to edit the UMD. Use the ENTER button to move the cursor. Press ENTER with the cursor on the character to be changed and use the Up/Down button to scroll through character options. Press ENTER to choose a character. Press MENU to return to the up menu and save the UMD setting.

***4. COLOR**

Use this setting to choose the color of the UMD text. Available colors are **red**, **green**, **yellow** and **white**. This setting does not affect text color when using UMD text via the Image Video or TSL protocols (text color is set via the protocols).

***5. ALIGN**

Use this setting to choose the horizontal alignment of the UMD text. UMD text can be justified on the **left**, **center** or **right** of the screen. This setting is overridden when using UMD text via the Image Video protocol (alignment is set via Image Video protocol).

***6. UMD Protocol**

Use the UMD Protocol menu option to choose the protocol with which the unit receives remote commands. Currently, four protocols are available.

■ **Image Video**

Use the Image Video protocol setting when controlling the UMD from an Image Video tally controller (e.g. TSI-1000) or other controlling device which utilizes the Image Video protocol. The **UMD ID**, **UMD Name(S/N)**, and **Baud Rate** parameters must be set for each screen in conjunction with the controlling device.

■ **TSL v4.0**

Use the TSL v4.0 protocol setting when controlling the UMD from a TSL tally controller, or other controlling device which utilizes the TSL v4.0 protocol. The **UMD ID** must be set for each screen in conjunction with the controlling device.

■ **TSL v3.1**

Use the TSL v3.1 protocol setting when controlling the UMD from a TSL tally controller, or other controlling device which utilizes the TSL v3.1 protocol. The **UMD ID** must be set for each screen in conjunction with the controlling device.

■ **LOCAL**

The static UMD is set by the local unit. The others of UMD Protocol can be set by Local and the corresponding protocols.

***7. UMD ID**

The UMD ID identifies each screen to the controlling device. When using the TSL protocol, the ID of each screen should be manually set in conjunction with the controlling device. When using the Image Video protocol, the ID may be set automatically by the controlling device, after each UMD is initially identified by UMD Name (see “UMD Name[S/N]” below). Available IDs are **000-255**.

***8. UMD Name (S/N)**

Use this setting to assign a name to each screen when using the Image Video protocol. **The UMD name is equivalent to the Image Video serial number and is used by the Image Video controlling device to identify each screen.** The default UMD Name(S/N) is “S00000.” It is recommended to maintain this naming scheme in order to avoid serial number conflicts with other Image Video devices on the same serial bus. Each name can be up to 16 ASCII characters. Press ENTER to edit the UMD. Use the ENTER button to move the cursor. Press ENTER with the cursor on the character to be changed and use the Up/Down button to scroll through character options. Press ENTER to choose a character. Press MENU to return to the up menu and save the UMD setting.

***9. UMD TLY Mode**

Use this setting when using Image Video tally control. Choose one of the following settings, in conjunction with the Image Video controlling device. **T1, T2, T1T2, T2T1, T1-, T2-, T1T2-, T2T1-**. Consult Image Video documentation for further information.

***10. UMD Baud Rate**

Use this setting to choose the baud rate. The baud rate must be set in conjunction with the controlling device. Available baud rates are **2400, 4800, 9600, 19200, 38400, 57600, 115200**.

***11. Tally Source**

The unit tally (OSD and LED) can be controlled in a variety of different ways. Use the Tally Source setting to choose how tally is controlled:

■ **Standard**

Use the Standard setting to control tally via contact closure on the DB-9 tally interface.

■ **Image Video HW**

Use the Image Video HW setting to control Image Video tally states via contact closure on the DB-9 tally interface. Contact closure of the **Red** pin corresponds to **Image Video Tally 1**, and the **Green** pin maps to **Image Video Tally 2**. Contact closure (ground) corresponds to a LOW state, and open circuit corresponds to a HIGH state. This mode requires the UMD Tally Mode parameter to be set. Consult Image Video documentation for further information.

■ **Image Video 422**

Use the Image Video 422 setting to control Image Video tally states via the Image Video serial protocol. This mode requires the UMD Tally Mode parameter to be set. Consult Image Video documentation for further information.

■ **Standard + IV422**

Use the Image Video 422 setting to control Image Video tally states via the Image Video serial protocol, while controlling LED and OSD tally using contact closure on the DB-9 tally interface. This mode requires the UMD Tally Mode parameter to be set. Consult Image Video documentation for further information.

■ **TSL**

Use the TSL setting to control OSD and LED tally via the TSL protocol.

5.6 USER CONTROL Sub-menu

PARAMETERS	Input Signal			Domain Range	NOTE
	CVBS	SD-SDI	HD-SDI		
SCAN	O	O	O	<u>NORMAL</u> ...UNDER SCAN	Used to adjust the image display scale. • NORMAL: 95% • UNDER SCAN:100%
SD ASPECT ¹	O	O	X	4:3... <u>16:9</u>	Used to adjust the screen Aspect Ratio.
H/V DELAY	X	O	O	<u>OFF</u> ...H...V...H/V	Used to observe the horizontal and vertical sync signals at the same time.
COLOR BAR ²	O	O	O	ON... <u>OFF</u>	

1. For “SD ASPECT” parameter:

SD ASPECT: The screen Aspect Ratio. The screen Aspect Ratio value: 4:3 and 16:9.

When the HD-SDI signal input, it will display in 16:9 by default.

Type/ input signal		SD ASPECT function	
		16:9	4:3
LMD9014-HSC (16:9 screen)	HD-SDI input signal	-	-
	SD-SDI input signal	✓	✓
	CVBS input signal	✓	✓
LMD9014-SC (16:9 screen)	SD-SDI input signal	✓	✓
	CVBS input signal	✓	✓
LMD9014-V (16:9 screen)	CVBS input signal	✓	✓

“✓”: Available ; “- ” Not available.

2. For “Color bar” parameter:

When opening the color bar, the screen information will be covered by the color bar for one minute.
The color bar also can be canceled by pressing the \wedge button, \vee button, “ENTER” button or “MENU” button.

5.7 USER CONFIG Sub-menu

PARAMETERS	Input Signal			Domain Range	NOTE
	CVBS	SD-SDI	HD-SDI		
VECTOR REF	O	O	O	100% CB ...75% CB	Used to set the reference value of the vectorscope. • 100% CB: 100% color bar • 75% CB: 75% color bar
OSD CONTROL	O	O	O	<u>ON</u> ...OFF	Except STATUS, it controls the switch of all OSD
WFM/ VT MODE	O	O	O	<u>SOLID</u> ...75% ...50%...25%	Used to set the transparence of the waveform and vectorscope. • SOLID :100%over cover the background • 75% :75%over cover the background • 50% :50%over cover the background • 25% :25%over cover the background
USER 1	O	O	O	<u>H/V DELAY</u>	See Chapter 4.3.2
USER2	O	O	O	<u>SD ASPECT</u>	See Chapter 4.3.2
USER 3	O	O	O	<u>WFM DISP</u>	See Chapter 4.3.2

Chapter 6 Technical Specifications

Product detailed information:

Number of Screens	1
Screen Display Ratio	15:9
Display Area(Viewing Area)	9" diagonal (7.795" (H) × 4.413" (V)) (198(H) mm×112.08(V) mm)
Viewing Angles	140°H × 120° V
Screen Colors (Bit Depth)	262K
Resolution (Dots)	800H × 480V
Pixel Pitch (mm)	0.2475(H) × 0.2335(V)
Contrast Ratio	400 :1
Pixel Response	<25ms typical
Luminance, White (cd /m²)	400
Back light	White CCFL
Dimensions	8.6" x 4.6" x 7.8" (219.5 x 118 x 198mm)
Power Consumption	12VDC/10 watts. – (3.8 Amps max –CE & UL complied supply included)
Operating Temperature	0° C to 70° C
Inputs	2 Auto-sensing HD-SDI / SD-SDI/ Analog Composite inputs (BNC); 2 pairs External analog audio inputs

Signal Format

LMD9014 are compatible with the following Signal Formats:

Product Number	Signal Formats
LMD9014-HSC	NTSC、 PAL
	480i-59.94、 576i-50
	1035i-59.94、 1035i-60、 1080i-50、 1080i-59.94、 1080i-60、 1080p-23.97、 1080p-24、 1080p-25、 1080p-29.97、 1080p-30、 1080PsF-23.97、 1080PsF-24、 720p-50、 720p-59.94、 720p-60、 720p-23.97、 720p-24、 720p-25、 720p-29.97、 720p-30
LMD9014-SC	NTSC、 PAL
	480i-59.94、 576i-50
LMD9014-V	NTSC、 PAL

The relationships between the actual display form (on the top left of the screen) and input signal format are as follows:

Signal Format	Support Form	Display Form
1080/60I	1080/60I	1080I60
	1080/59.94I	1080I59.94
1080/50I	1080/50I	1080I50
1080/30P	1080/30P	1080P30
	1080/29.97P	1080P29.97
1080/25P	1080/25P	1080P25
1080/24P	1080/24P	1080P24
	1080/23.97	1080P23.97
1080/24PsF	1080/24PsF	1080sF24
	1080/23.97PsF	1080Sf23.97
1035/60I	1035/60I	1035I60
	1035/59.94I	1035I59.94
720/60P	720/60P	720P60
	720/59.94P	720P59.94
720/50P	720/50P	720P50
720/30P	720/30P	720P30
	720/29.97P	720P29.97
720/25P	720/25P	720P25
720/24P	720/24P	720P24
	720/23.97P	720P23.97
576/50I	576/50I	576I50
480/60I	480/59.94I	480I60
NTSC	NTSC	NTSC
PAL	PAL	PAL

Dimensions:

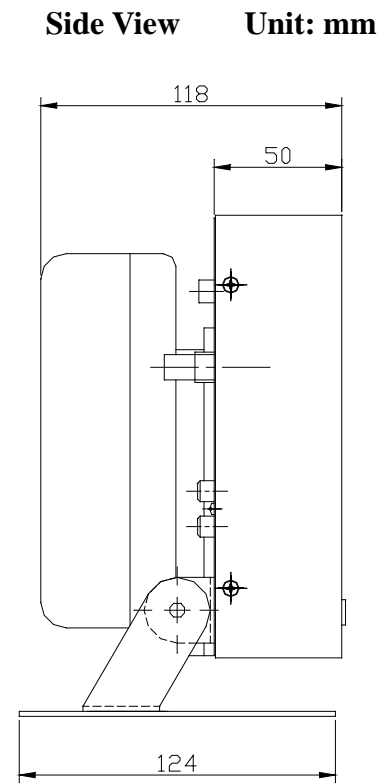
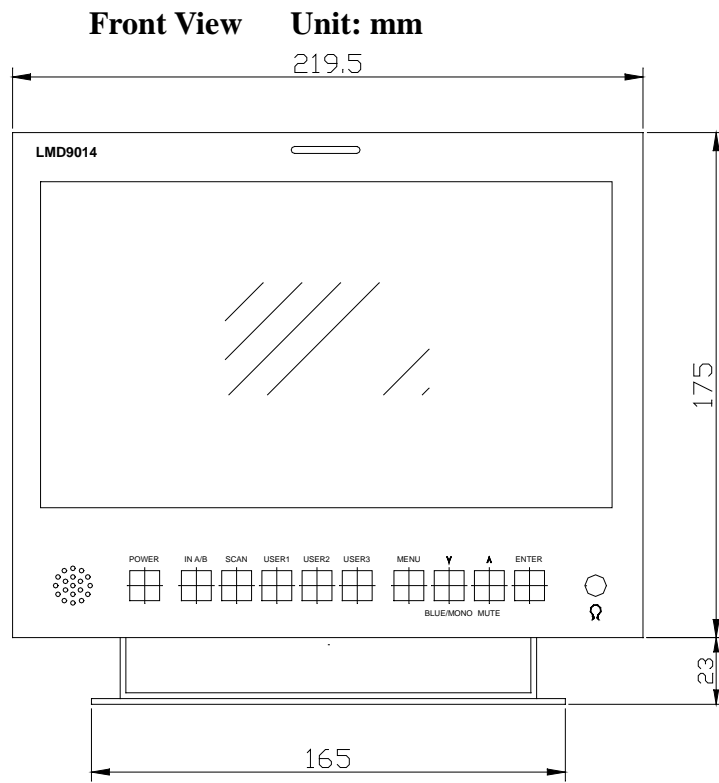

Rear View Unit: mm

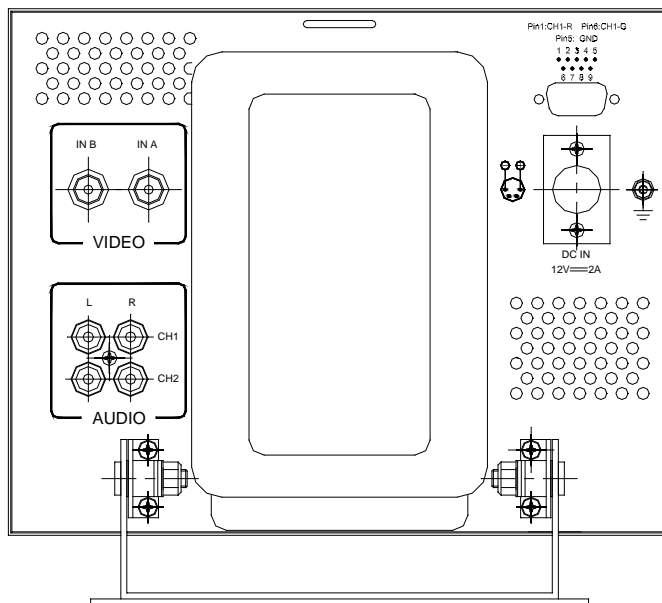

Chapter 7 Supplying the power

An Anton/Bauer or V-mount type of battery pack (Optional units) or an external DC power supply can be used to power this monitor.

◆ Using the Anton/Bauer type of battery pack

1. Install the Anton/Bauer type of battery pack.
2. Insert the battery pack. And slide it in the direction of the arrow.
To remove the battery pack, slide it in the opposite direction to the one in which it was attached while keeping the release lever on the battery holder pulled down all the way.

◆ Using a V-mount type of battery pack

Caution: These servicing instructions are for use by qualified service personnel only. To reduce the risk of electric shock, do not perform any servicing other than that contained in the operating instructions unless you are qualified to do so.

1. Remove the battery holder.
2. Loosen the six screws (length 10mm X M3) of the V-mount type battery holder to unpack it.
3. Fix the bottom of V-mount type battery holder with four screws (length 9mm X M3) supplied with the holder.
4. Install the accessory battery mount terminal block.
5. Fasten the other of V-mount type battery holder with four screws (length 10mm X M3) on the original position.
6. Insert the battery pack. And side it in the direction of the arrow.
To remove the battery pack, slide it in the opposite direction to the one in which it was attached while keeping the release lever on the battery holder pulled down all the way.

◆ Connect the external DC power supply to the DC IN socket on this unit.

Caution:

If an external DC power supply is used, then check the ratings of the external DC power supply so that they are compatible with those of this unit.

Check the pin arrangement of the DC output terminal of the external DC power supply and those of the DC IN socket of this unit so that their polarities are correctly arranged.

If +12V are supplied to the unit's GND terminal by mistake, this may cause fire or injury.

DC IN socket

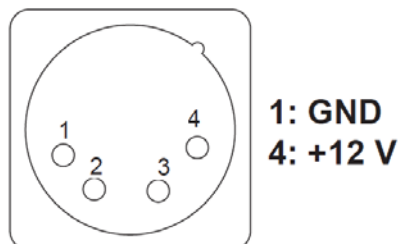

Chapter 8 Warranty for LCD Monitor

What the warranty covers:

osee warrants its products to be free from defects in material and workmanship during the warranty period of one year from purchase date. If a product proves to be defective in material or workmanship during the warranty period, osee will, at its sole option, repair or replace the product with a similar product. The replacement unit will be covered by the balance of the time remaining on the customer's original limited warranty.

No sales personnel of the seller or any other person is authorized to make any warranties other than those described above, or to extend the duration of any warranties on behalf of osee, beyond the time period describe above.

This warranty is extended to the first consumer only, and proof of purchase is necessary to honor the warranty. If there is no proof of purchase provided with a warranty claim, osee reserves the right not to honor the warranty set forth above. Therefore, labor and parts may be charged to the consumer.

What the warranty does not cover:

1. Any product, on which the serial number has been defaced, modified or removed.
2. Damage, deterioration or malfunction resulting from:
 - Accident, misuse, neglect, fire, water, lightning, or other acts of nature, unauthorized product modification, or failure to follow instructions supplied with the product
 - Repair or attempted repair by anyone not authorized by osee
 - Any damage of the product due to shipment.
 - Removal or installation of the product.
 - Causes external to the product, such as electric power fluctuations or failure.
 - Use of supplies or parts not meeting osee product's specifications.
 - Normal wear and tear.
 - Any other cause which does not relate to a product defect.